

### 湊中央線 標準断面図

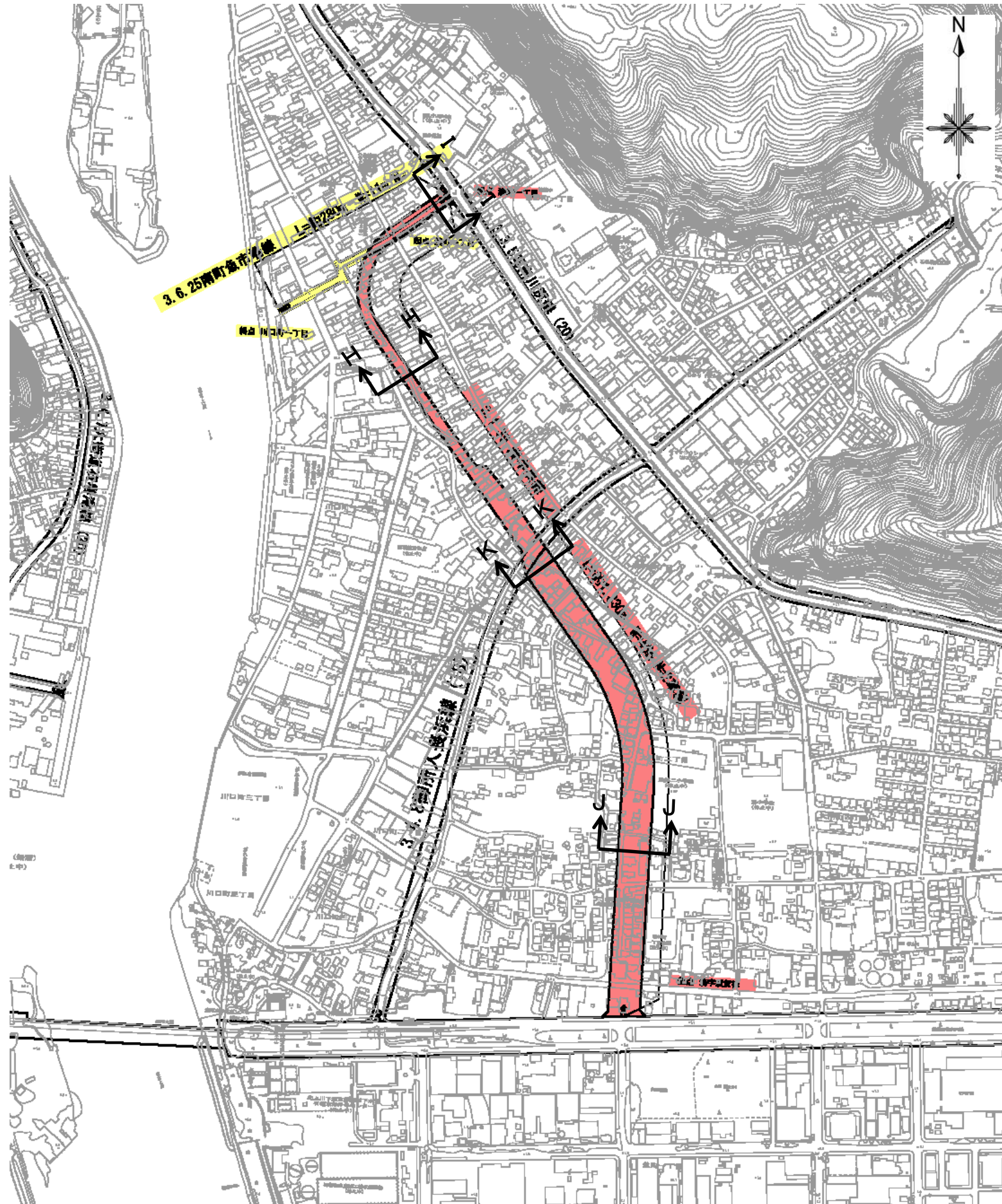

標準部 (H-H断面)

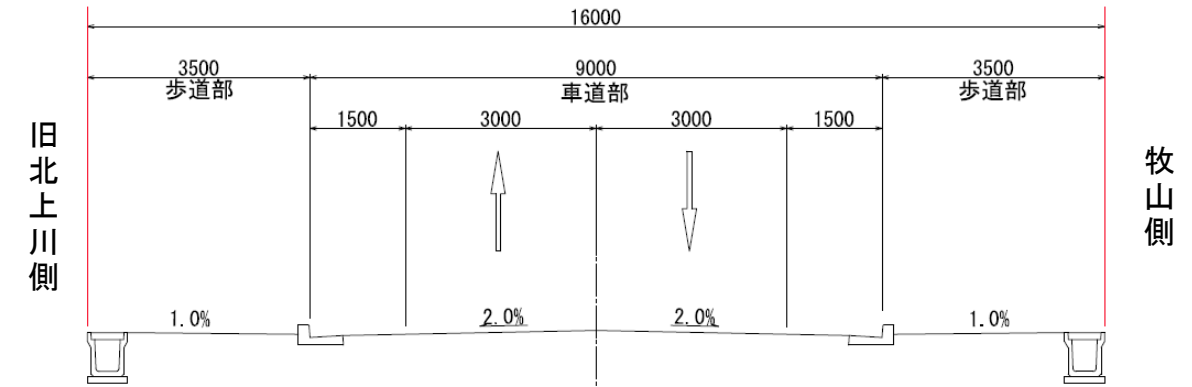

交差点部 (I-I断面)

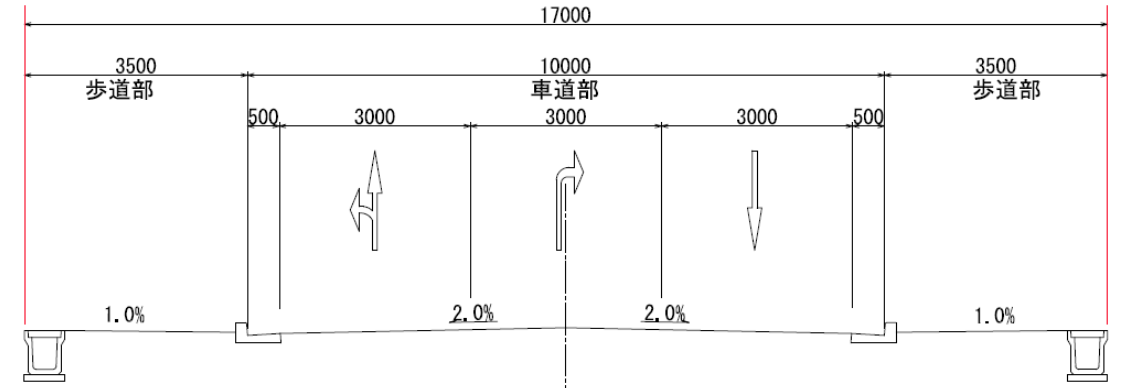

高盛土部 (J-J断面)

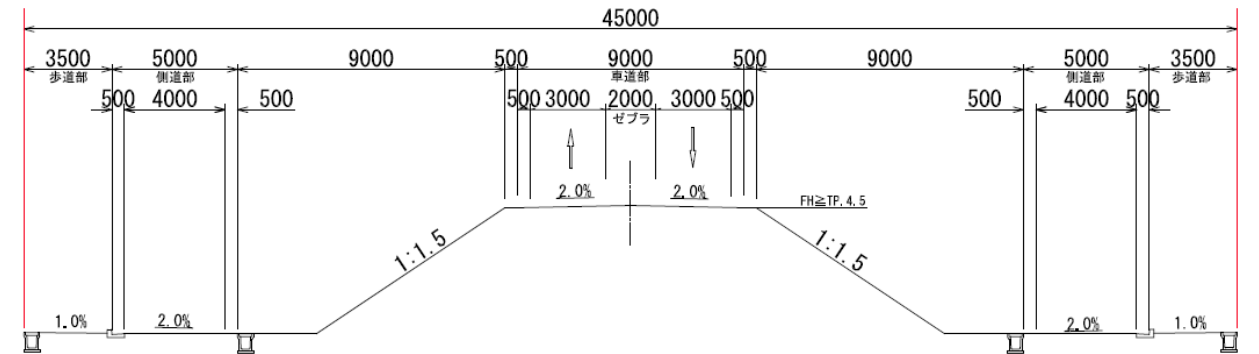

高盛土交差点部 (K-K断面)

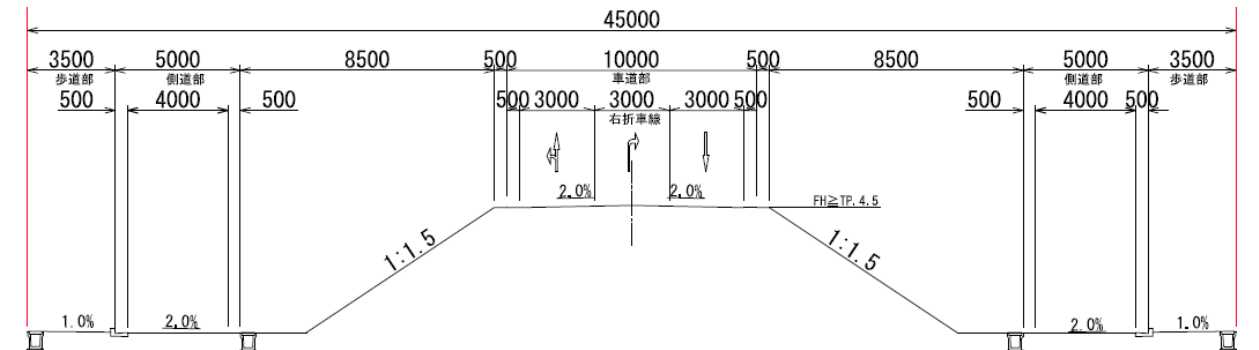



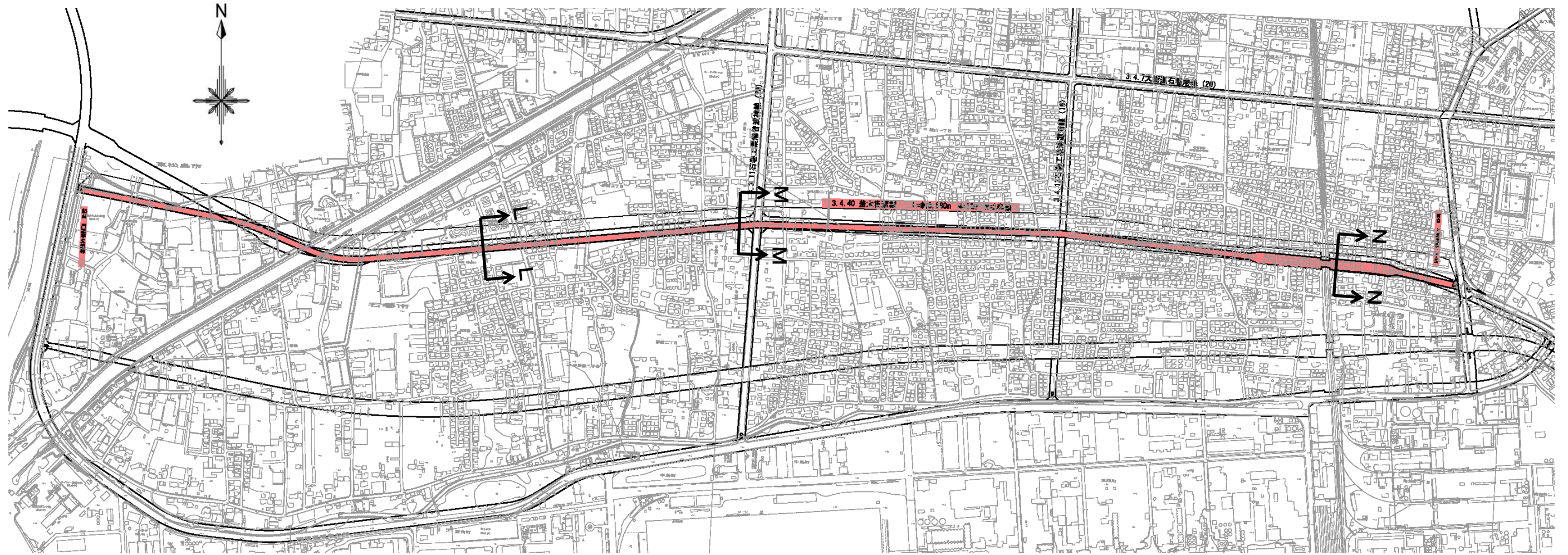

### 釜大街道線 標準断面図

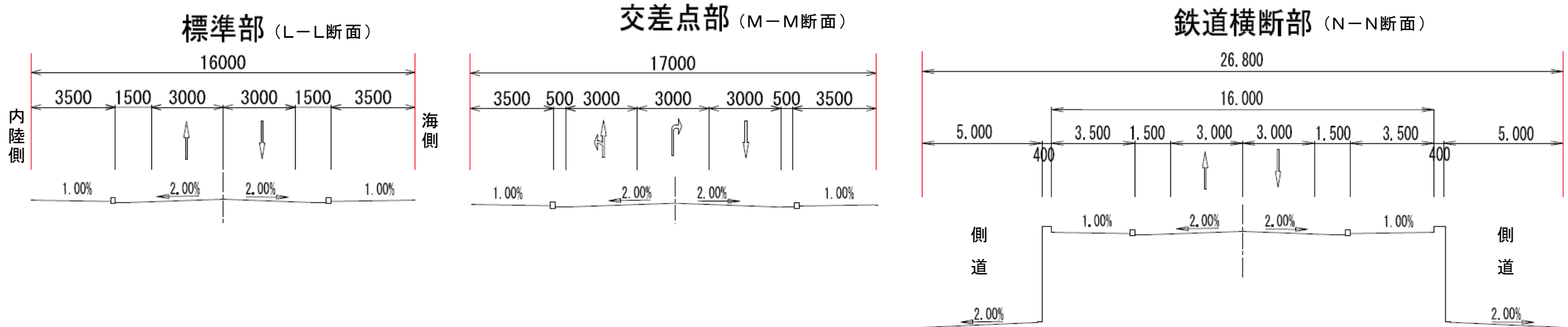



### 緑地部断面図

#### A-A断面図

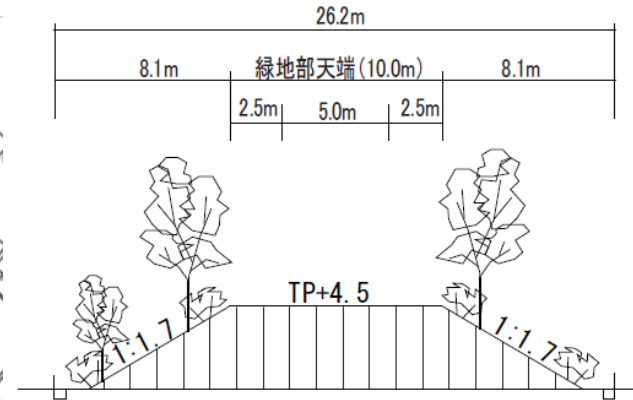

#### B-B断面図

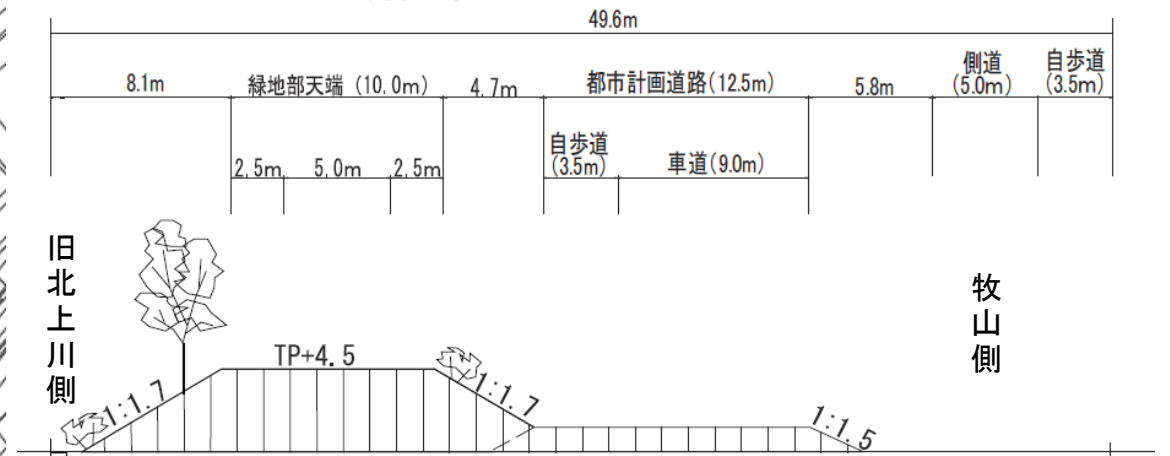

#### C-C断面図

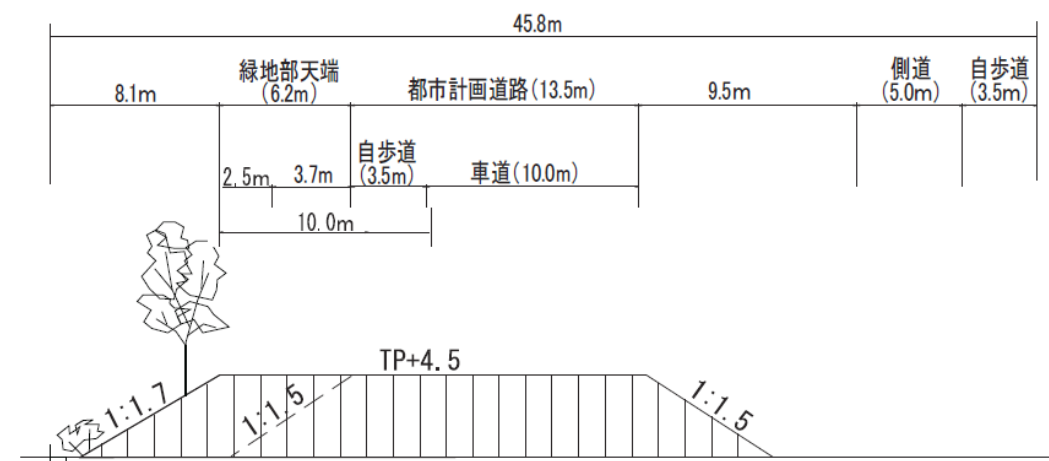

### 防災緑地1号平面図

